

# drinkpure

HOME

swiss made



Your source for  
healthy & natural water



# DrinkPure HOME – Your source for healthy & natural water

DrinkPure HOME turns every faucet into a source of healthy and natural tasting water

**If it really has to be safe:** Our revolutionary water filter is the only faucet filter on the market that removes microplastics and pathogens. This has been approved by accredited laboratories. DrinkPure HOME also reduces any undesired smell and taste (e.g. chlorine), as well as pesticides and hormones from your tap water.

Just screw DrinkPure HOME to your faucet and enjoy great tasting water immediately at the highest flow rate available. With our QuickFix adapter, you can decide within seconds if your water should be filtered or unfiltered.

One filter cartridge lasts up to two months. The cartridge then needs replacement with a new one. Start filtering today and switch to DrinkPure HOME. It will save you time and money.

Easy to install / mount within seconds

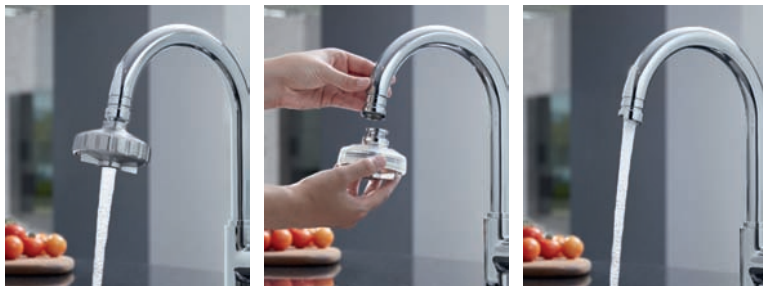

## Performance Data

Flow Rate	3.5 L/min @ 3 bar
Capacity	up to 500 Liter / approx.. 2 months
Pressure	min. 0.5 bar, max. 4 bar
Temperature	min. 3°C, max. 70°C

**WARNINGS** Do not use with water that is microbiologically unsafe, or of unknown quality, without adequate disinfection before or after the system. Individuals requiring water of certain microbiological purity should consult their physician. Install in compliance with local and state regulations.



Filters sediments



Removes  
99.9999% bacteria



Removes  
99% viruses



Filters microplastics  
and rust



Reduces odors,  
pesticides & hormones



Tap water  
use



Replaceable core/  
reduces  
bottle waste  $\geq 99\%$



Simple use,  
up to 500 L



Self  
disinfecting

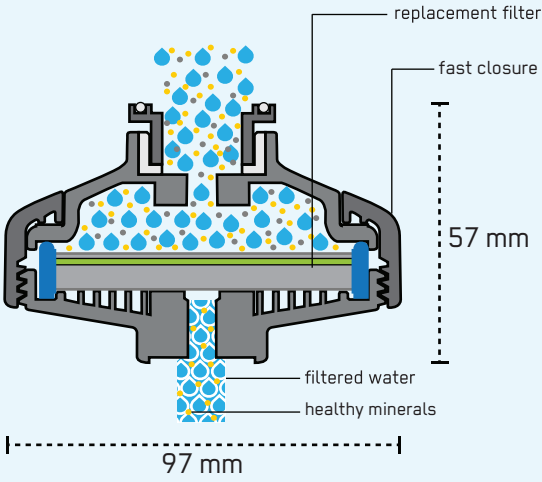

## Faucet filtration system with replaceable filter

- ▶ 3x smaller than any other system available on the market
- ▶ Replaceable filter last up to 500 liters (~2 Months)
- ▶ Fits all standard faucets (M22 & M24) and is easy to install
- ▶ Healthy minerals stay in your water
- ▶ Unbeatable price/performance ratio reduces your water cost up to 1'000 USD per year<sup>1</sup>

## Multilevel replacement filter

- ▶ Supports you in preparing your baby food, tea and coffee
- ▶ Preserves the natural mineral content of your water
- ▶ For the reduction of microplastics, rust and bacteria

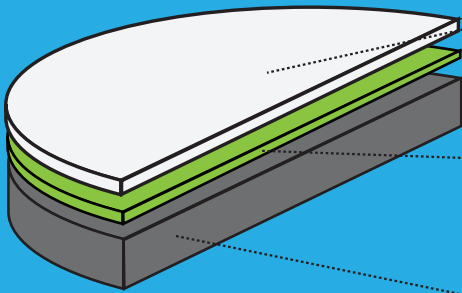

The fine **prefilter media** protects the **membrane** from high load of larger particles (e.g. sand). Therefore, the membrane can filter over a longer period.



The patented **membrane filters smallest particles** (e.g. rust or microplastics), **as well as germs** from your tap water. Make your water safe again!



Activated carbon **removes odors** (e.g. chlorine) & pesticides. Further, a self disinfecting surface prevents filter contamination.

<sup>1</sup> average annual water consumption of a family of four at 0.3 USD per liter of bottled water

## Patented technology EP2665767 (B1)

The DrinkPure HOME water filtration system uses a multilayer filter for your comfort and safety. The core of each filter is the patented Novamem DrinkPure™ membrane, which has been invented by engineers from the Swiss Federal Institute of Technology (ETH). Thanks to the over 3 billion pores, germs are retained without a large reduction of the flow rate. The result is DrinkPure HOME - The smallest filter not relying on chemistry.

## About us

DrinkPure is the brand of the Swiss company Novamem Ltd. Novamem is the inventor of this technology and is the first to implement it worldwide. Our customers profit with DrinkPure water filters from unrivalled flow rates at highest comfort levels. Try it yourself today and switch to the experts in water filtration.

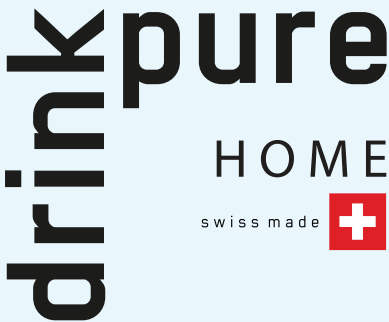

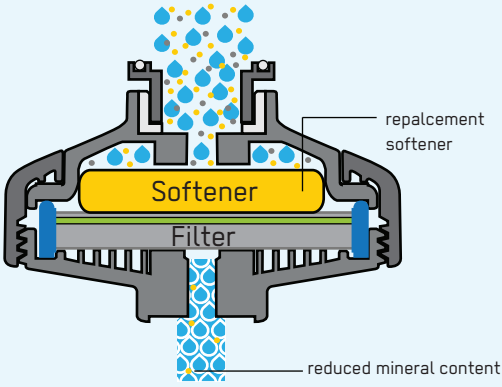

## Your water - Your choice! Reduce limescale taste with our optional softener cartridge

- ▶ Replaceable softener can last up to 20 days
- ▶ Partial softening of water renders water taste more soft
- ▶ Can be added to all DrinkPure HOME filters
- ▶ No complete dehardening - Healthy minerals are still in your water

# Meet our DrinkPure HOME Family

### Starter Kits

- ▶ 1x filter housing
- ▶ 1x filter cartridge
- ▶ 1x softener cartridge
- ▶ 1x fast coupling system



**DrinkPure HOME - basic**  
standard plastic housing



**DrinkPure HOME - chrome**  
chromed plastic housing

### Replacement Sets

- ▶ 3x cartridges



**1/2 Year Replacement Set**  
Set of three filters, each  
filtering ~ 2 months



**2 Months Replacement Set**  
Set of three softeners, each  
filtering ~ 20 days

**drinkpure**  
HOME  
swiss made 





# Water filtration system take back the tap!

## Compatibility

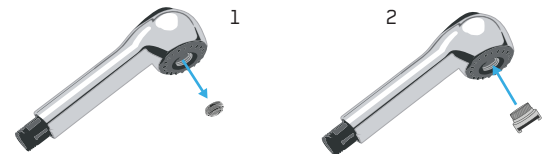
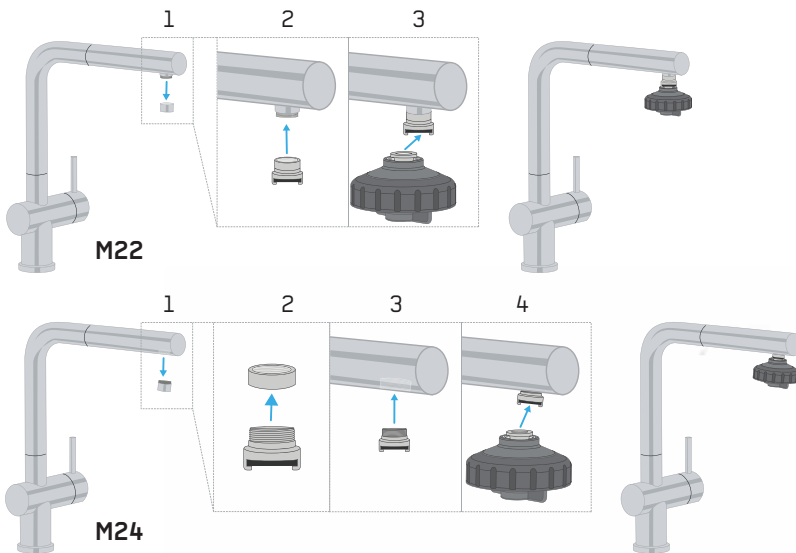

Compatible with kitchen sprays that  
have an unscrewable aerator



**Novamem DrinkPure™**, a brand by Novamem Ltd.  
Rütistrasse 16, CH-8952 Schlieren

**Questions? - Send us your picture!**  
WhatsApp + 41 77 499 33 69  
Phone +41 (0) 44 533 26 40  
[info@drinkpure-waterfilter.com](mailto:info@drinkpure-waterfilter.com)



## Exchange of filter cartridges

- ▶ Filters may clog over time which is noticeable by a reduced flow rate. We recommend to exchange your filter cartridge at least every two months.
- ▶ Remove and dispose of the old cartridge (household waste).
- ▶ Unpack the new cartridge and place it into the filter with the white side up.
- ▶ Close the filter housing and mount the filter to your faucet via QuickFix.

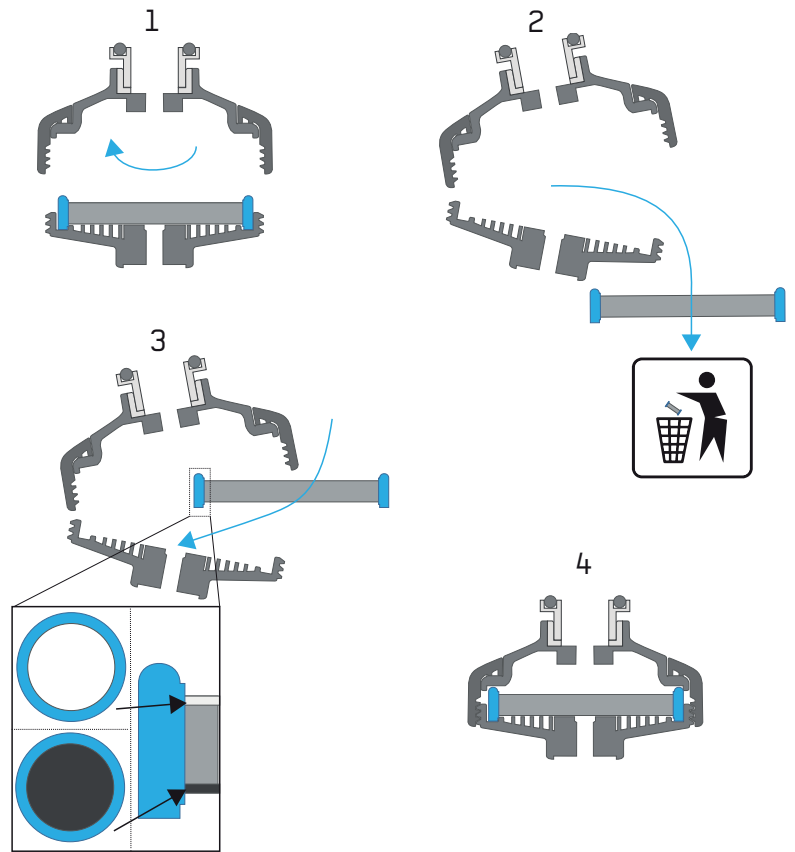

# Filter exchange

## Exchange of softener cartridges

- ▶ Remove and dispose of the old cartridge (household waste).
- ▶ Unpack the new cartridge and place it on top of the filter cartridge.
- ▶ Close the filter housing and mount the filter to your faucet via QuickFix.

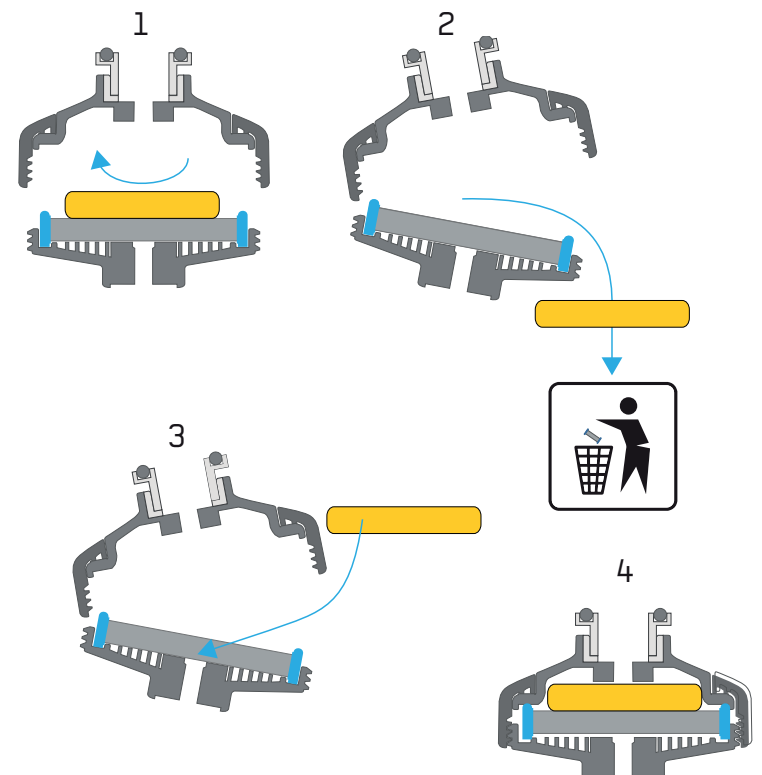

**drinkpure**  
HOME  
swiss made 